

T68.S6...
Hob

 **BUY NOW**

[en] INSTRUCTION MANUAL





























		g^*	b^*
A / B		2.200 W	3.700 W
		3.300 W	3.700 W
		2.600 W	3.700 W
		3.300 W	3.700 W

*  IEC 60335-2-6

Table of contents

	Intended use	5		ShortBoost function	21
	Important safety information	6	Recommendations for use	21	
	Causes of damage	7	Activating	21	
	Overview	7	Deactivating	21	
	Environmental protection	8		Keep warm function	21
	Energy-saving advice	8	Activation	21	
	Environmentally-friendly disposal	8	Deactivation	21	
	Induction cooking	8		Transferring settings	22
	Advantages of induction cooking	8	Activation	22	
	Cookware	8		Frying Sensor	22
	Getting to know your appliance	10	Advantages when frying	22	
	The control panel	10	For frying with the frying sensor	22	
	The hotplates	11	Temperature settings	23	
	Residual heat indicator	11	Table	23	
	Twist-Pad with Twist knob	12	Setting procedure	25	
	Remove the twist knob	12		Childproof lock	25
	Storing the twist knob	12	Activating and deactivating the childproof lock	25	
	Operating the hob without the twist knob	12	Childproof lock	25	
	Operating the appliance	13		Wipe protection	26
	Switching the hob on and off	13		Automatic safety cut-out	26
	Setting a hotplate	13		Basic settings	27
	Chef's recommendations	13	To access the basic settings:	28	
	Flex Zone	16		Energy consumption indicator	29
	Advice on using cookware	16		Cookware check	29
	As two independent hotplates	16		Home Connect	30
	As a single hotplate	16	Setting up	30	
	Move function	17	Home Connect settings	31	
	Activation	17	Software update	33	
	Deactivating	17	About data protection	33	
	FlexPlus Zone	18	Declaration of Conformity	33	
	Notes regarding cookware	18		Hood connection	34
	Activation	18	Setting up	34	
	Deactivating	18	Resetting connection	35	
	Time-setting options	19	Control the hood via the hob	35	
	Programming the cooking time	19	Hood control settings	35	
	The kitchen timer	19		Cleaning	36
	Stopwatch function	20	Hob	36	
	PowerBoost function	20	Hob surround	36	
	Activating	20	Twist knob	36	
	Deactivating	20			

 Frequently Asked Questions (FAQ)	37
 Trouble shooting	38
 Customer service	39
E number and FD number	39
 Test dishes	40

Additional information on products, accessories and services can be found at **neff** and in the online shop **banyo.co.uk**

Intended use

Read these instructions carefully. Please keep the instruction and installation manual, as well as the appliance certificate, in a safe place for later use or for subsequent owners.

Check the appliance after removing it from the packaging. If it has suffered any damage in transport, do not connect the appliance, contact the Technical Assistance Service and provide written notification of the damage caused, otherwise you will lose your right to any type of compensation.

Only a licensed professional may connect appliances without plugs. Damage caused by incorrect connection is not covered under warranty.

This appliance must be installed according to the installation instructions included.

This appliance is intended for private domestic use and the household environment only. The appliance must only be used for the preparation of food and beverages. The cooking process must be supervised. A short cooking process must be supervised without interruption. Only use the appliance in enclosed spaces.

This appliance is intended for use up to a maximum height of 4000 metres above sea level.

Do not use covers. These can cause accidents, for example due to overheating, catching fire or materials shattering.

Only use safety devices or child protection grilles approved by ourselves. Unsuitable safety devices or child protection grilles may result in accidents.

This appliance is not intended for operation with an external clock timer or a remote control.

This appliance may be used by children over the age of 8 years old and by persons with reduced physical, sensory or mental capabilities or by persons with a lack of experience or knowledge if they are supervised or are instructed by a person responsible for their safety how to use the appliance safely and have understood the associated hazards.

Children must not play with, on, or around the appliance. Children must not clean the appliance or carry out general maintenance unless they are at least 15 years old and are being supervised.

Keep children below the age of 8 years old at a safe distance from the appliance and power cable.

We advise that you exercise caution using or standing near an induction hob while it is in operation, if you wear a pacemaker or a similar medical device. Consult your doctor or the device manufacturer concerning its conformity or any possible incompatibilities,

Important safety information

Warning – Risk of fire!

- Hot oil and fat can ignite very quickly. Never leave hot fat or oil unattended. Never use water to put out burning oil or fat. Switch off the hotplate. Extinguish flames carefully using a lid, fire blanket or something similar.
- The hotplates become very hot. Never place combustible items on the hob. Never place objects on the hob.
- The appliance gets hot. Do not keep combustible objects or aerosol cans in drawers directly underneath the hob.
- The hob switches off automatically and can no longer be operated. It may switch on unintentionally at a later point. Switch off the circuit breaker in the fuse box. Contact the after-sales service.
- Do not use hob covers here. They can cause accidents, for example due to overheating, catching fire or materials shattering.

Warning – Risk of burns!

- The hotplates and surrounding area (particularly the hob surround, if fitted) become very hot. Never touch the hot surfaces. Keep children at a safe distance.
- The hotplate heats up but the display does not work. Switch off the circuit breaker in the fuse box. Contact the after-sales service.
- Metal objects on the hob quickly become very hot. Never place metal objects (such as knives, forks, spoons and lids) on the hob.
- After each use, always turn off the hob at the main switch. Do not wait until the hob turns off automatically after the pan is removed.

Warning – Risk of electric shock!

- Incorrect repairs are dangerous. Repairs may only be carried out and damaged power cables replaced by one of our trained after-sales technicians. If the appliance is defective, unplug the appliance from the mains or switch off the circuit breaker in the fuse box. Contact the after-sales service.
- Do not use any high-pressure cleaners or steam cleaners, which can result in an electric shock.
- A defective appliance may cause electric shock. Never switch on a defective appliance. Unplug the appliance from the mains or switch off the circuit breaker in the fuse box. Contact the after-sales service.
- Cracks or fractures in the glass ceramic may cause electric shocks. Switch off the circuit breaker in the fuse box. Contact the after-sales service.

Warning – Hazard due to magnetism!

The removable control element is magnetic. Magnets may affect electronic implants, e.g. heart pacemakers or insulin pumps. Thus, for persons with electronic implants: avoid carrying the control element in clothing pockets; keep a minimum distance of 10 cm to heart pacemaker or device.

Warning – Malfunction risk!

The hob is equipped with a fan in the lower section. If there is a drawer under the hob it should not be used to store small objects or paper, since they could damage the fan or interfere with the cooling if they are sucked into it.

There should be a minimum of 2 cm between the contents of the drawer and fan intake.

Warning – Risk of injury!

- When cooking in a bain marie, the hob and cooking container could shatter due to overheating. The cooking container in the bain marie must not directly touch the bottom of the water-filled pot. Only use heat-resistant cookware.
- Saucepans may suddenly jump due to liquid between the pan base and the hotplate. Always keep the hotplate and saucepan bases dry.

Causes of damage

Caution!

- Rough pan bases may scratch the hob.
- Avoid leaving empty pots and pans on the hotplate. Doing so may cause damage.
- Do not place hot pans on the control panel, the indicator area, or the hob frame. Doing so may cause damage.
- Hard or pointed objects dropped on the hob may damage it.
- Aluminium foil and plastic containers will melt if placed on the hotplate while it is hot. The use of laminated sheeting is not recommended on the hob.

Overview

You will find the most frequently caused damage in the following table:

Damage	Cause	Measure
Stains	Boiled over food.	Remove boiled over food immediately with a glass scraper.
	Unsuitable cleaning agent.	Only use cleaning agents that are suitable for this type of hob.
Scratches	Salt, sugar and sand.	Do not use the hob as a work surface or storage space.
	Cookware with rough bases scratch the hob.	Check the cookware.
Discolouration	Unsuitable cleaning agent.	Only use cleaning agents that are suitable for this type of hob.
	Pan abrasion.	Lift pots and pans when moving them.
Chips	Sugar, food with a high sugar content.	Remove boiled over food immediately with a glass scraper.

Environmental protection

In this section, you can find information about saving energy and disposing of the appliance.

Energy-saving advice

- Always use the correct lid for each pan. Cooking without a lid uses a lot more energy. Use a glass lid to provide visibility and avoid having to lift the lid.
- Use pans with flat bases. Bases that are not flat use a lot more energy.
- The diameter of the pan base must match the size of the hotplate. Please note: pan manufacturers usually provide the diameter for the top of the pan, which is usually larger than the diameter of the pan base.
- Use a small pan for small amounts of food. A large pan which is not full uses a lot of energy.
- Use little water when cooking. This saves energy and preserves all the vitamins and minerals in vegetables.
- Select the lowest power level to maintain cooking. If the power level is too high, energy is wasted.

Environmentally-friendly disposal

Dispose of packaging in an environmentally-friendly manner.



This appliance is labelled in accordance with European Directive 2012/19/EU concerning used electrical and electronic appliances (waste electrical and electronic equipment - WEEE). The guideline determines the framework for the return and recycling of used appliances as applicable throughout the EU.

Induction cooking

Advantages of induction cooking

Induction cooking is very different from traditional cooking methods, as heat builds up directly in the item of cookware. This offers numerous advantages:

- Saves time when boiling and frying.
- Saves energy.
- Easier to care for and clean. Spilled food does not burn on as quickly.
- Heat control and safety – the hob increases or decreases the heat supply as soon as the user changes the setting. The induction hotplate stops the heat supply as soon as the cookware is removed from the hotplate, without having to switch it off first.

Cookware

Only use ferromagnetic cookware for induction cooking, such as:

- Cookware made from enamelled steel
- Cookware made from cast iron
- Special induction-compatible cookware made from stainless steel.

To check whether your cookware is suitable for induction cooking, refer to the section on → "Cookware check".

To achieve a good cooking result, the ferromagnetic area on the base of the pan should match the size of the hotplate. If a hotplate does not detect an item of cookware, try placing it on another hotplate with a smaller diameter.

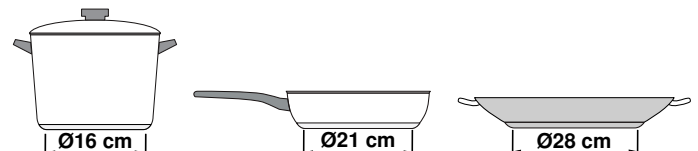

If the only hotplate being used is the flexible cooking zone, larger cookware that is particularly suited to this zone can be used. You can find information on positioning cookware in the section on → "Flex Zone".



Some induction cookware does not have a fully ferromagnetic base:

- If the base of the cookware is only partially ferromagnetic, only the area that is ferromagnetic will heat up. This may mean that heat will not be distributed evenly. The non-ferromagnetic area may not heat up to a sufficient temperature for cooking.

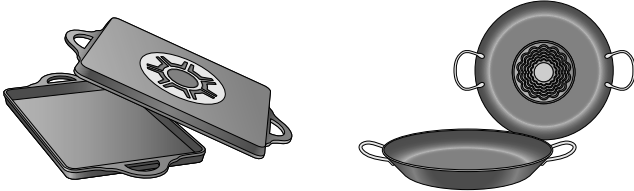

- The ferromagnetic area will also be reduced if the material from which the base of the cookware is made contains aluminium, for example. This may mean that the cookware will not become sufficiently hot or even that it will not be detected.

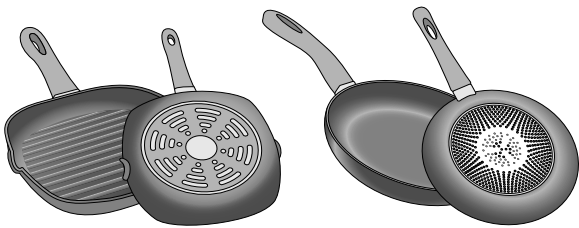

Unsuitable pans

Never use diffuser hobs or pans made from:

- common thin steel
- glass
- earthenware
- copper
- aluminium

Properties of the base of the cookware

The material(s) from which the base of the cookware is made can affect the cooking result. Using pots and pans made from materials that distribute heat evenly through them, such as stainless-steel pans with a three-layer base, saves time and energy.

Use cookware with a flat base; if the base of the cookware is uneven, this may impair the heat supply.

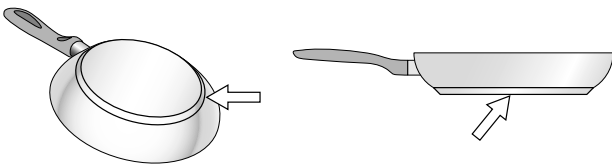

Absence of pan or unsuitable size

If no pan is placed on the selected hotplate, or if it is made of unsuitable material or is not the correct size, the power level displayed on the hotplate indicator will flash. Place a suitable pan on the hotplate to stop the flashing. If this takes more than 90 seconds, the hotplate will switch off automatically.

Empty pans or those with a thin base

Do not heat empty pans, nor use pans with a thin base. The hob is equipped with an internal safety system. However, an empty pan may heat up so quickly that the "automatic switch off" function may not have time to react and the pan may reach very high temperatures. The base of the pan could melt and damage the glass on the hob. In this case, do not touch the pan and switch the hotplate off. If it fails to work after it has cooled down, please contact the Technical Assistance Service.

Pan detection

Each hotplate has a lower limit for pan detection. This depends on the diameter of the ferromagnetic area of the cookware and the material from which its base is made. For this reason, you should always use the hotplate that best matches the diameter of the base of the pan.

Getting to know your appliance

You can find information on the dimensions and power of the hotplates in → *Page 2*

The control panel

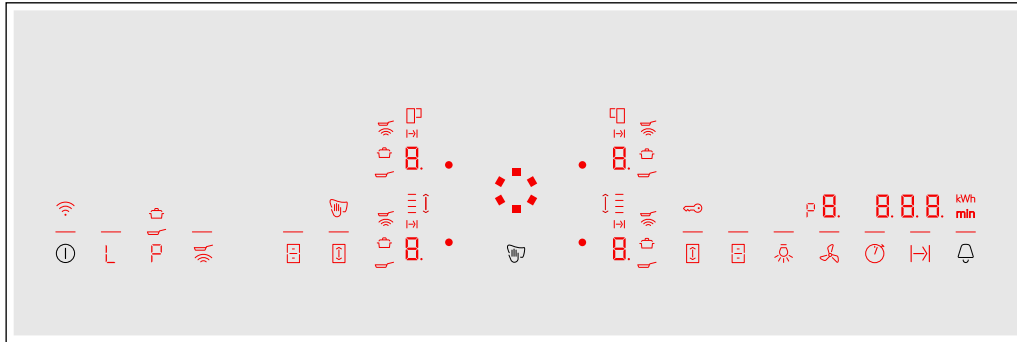

Touch controls	
	Main switch
	Keep-warm function
	PowerBoost and ShortBoost functions
	Frying sensor
	Flexible cooking zone
	Move function
	Stopwatch function
	Set the cooking time
	Timer and childproof lock
	Hood control
	Extractor hood lighting

Indicators/symbols	
	Operating status
	Heat settings
	Residual heat
	PowerBoost and ShortBoost functions
	PowerBoost function
	ShortBoost function
	Keep-warm function
	Frying sensor
	Flexible cooking zone
	Move function
	FlexPlus cooking zone
	Set the cooking time
	Timer function
	Time
	Childproof lock
	Lock the control panel for cleaning
	Energy consumption
	Wi-Fi

Controls



When the hob heats up, the symbols for the controls available at this time light up.

Touching a symbol activates the respective function.

Notes

- The corresponding symbols for the controls light up depending on whether they are available. The displays for the hotplates or the selected functions get brighter.
- Always keep the control panel clean and dry. Moisture can prevent it from working properly.
- Do not place any cookware near the indicators or sensors. The electronics could overheat.

The hotplates

Hotplate		
	Simple hotplate	Use cookware that is a suitable size.
	Flexible cooking zone	See section → " <i>Flex Zone</i> "
	FlexPlus cooking zone	The FlexPlus cooking zones always switch on in conjunction with the right- or left-hand flexible cooking zone. See section → " <i>FlexPlus Zone</i> "
Only use cookware that is suitable for induction cooking; see section → " <i>Induction cooking</i> "		

Residual heat indicator

The hob has a residual heat indicator for each hotplate. This indicates that a hotplate is still hot. Do not touch a hotplate while the residual heat indicator is lit up.

The following indicators are shown depending on the amount of residual heat:

- Display **H**: High temperature
- Display **h**: Low temperature

If you remove the cookware from the hotplate during cooking, the residual heat indicator and the selected heat setting will flash alternately.

When the hotplate is switched off, the residual heat indicator will light up. Even after the hob has been switched off, the residual heat indicator will stay lit for as long as the hotplate is still warm.

Twist-Pad with Twist knob

The twistpad is the area in which you can use the twist knob to select the hotplates and heat settings. The twist knob automatically centres itself in the twistpad area.

The twist knob is magnetic and is placed on top of the twistpad. To activate a hotplate, touch the twist knob at the level for the required hotplate. Turning the twist knob selects the heat setting.

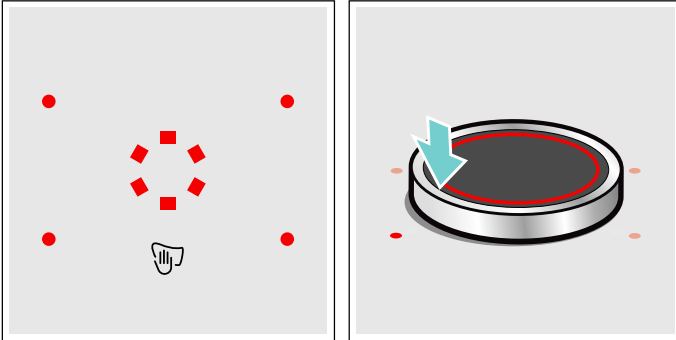

Position the twist knob on the twist pad so that it is in the centre of the indicators which delimit the twist pad area.

Notes

- Even if the twist knob is not entirely central, this will not affect how the twist knob works.
- Always keep the twist knob clean. Soiling may impair its function.

Remove the twist knob.

If the twist knob is removed, the "Lock control panel for cleaning" function is activated.

The twist knob can be removed during cooking. The "Lock control panel for cleaning" function is activated for 35 seconds. If the twist knob is not placed back in position before this time elapses, the hob switches off.

Warning – Risk of fire!

If during this 35 seconds a metallic object is placed in the twistpad area, the hob may continue to heat up. Therefore, always switch off the hob using the main switch.

Storing the twist knob





A strong magnet is located inside of the twist knob. Keep the twist knob away from magnetic data carriers such as credit cards and cards with magnetic strips. Otherwise, these data carriers may be damaged beyond repair.

The magnet could also cause faults on televisions and screens.

Note: The twist knob is magnetic. Metal particles stuck to the bottom could scratch the surface of the hob. Always clean the twist knob thoroughly.

Operating the hob without the twist knob

The hob can also be operated without the twist knob:

1. Switch on the hob using the main switch.
2. Within the next 5 seconds, simultaneously touch and hold the  and  symbols for 4 seconds. An audible signal will sound.
3. Touch the  symbol repeatedly until the indicator for the required hotplate lights up.
4. Then set the required heat setting using the  or  symbol.

The hotplate has now been activated.

Notes



- The timer function cannot be activated without the twist knob.
- The twist knob can be placed back on the twistpad at any time.

Operating the appliance

This chapter explains how to set a hotplate. The table shows heat settings and cooking times for various meals.

Switching the hob on and off

Switch the hob on and off using the main switch.

To switch on: Touch the  symbol. The symbols for the hotplates and the functions available at this time light up.  lights up next to the hotplates. Position the twist knob in the area in which it can be used. The hob is ready for use.

To switch off: Touch the  symbol until the indicator goes out. All hotplates are switched off. The residual heat indicator remains lit until the hotplates have cooled down sufficiently.

Notes

- The hob switches off automatically if all hotplates have been switched off for more than 15 seconds.
- The selected settings are stored for four seconds after the hob has been switched off. If the hob is switched on again within this time, the previous settings are applied.

Setting a hotplate

Set the required heat setting using the twist knob.

Heat setting 1 = lowest setting.

Heat setting 9 = highest setting.

Every heat setting has an intermediate setting. This is marked with a dot.

Selecting a hotplate and heat setting

The hob must be switched on.

1. Select the hotplate. To do this, touch the twist knob in the appropriate area for the required hotplate.
2. Turn the twist knob until the required heat setting appears in the heat setting display.

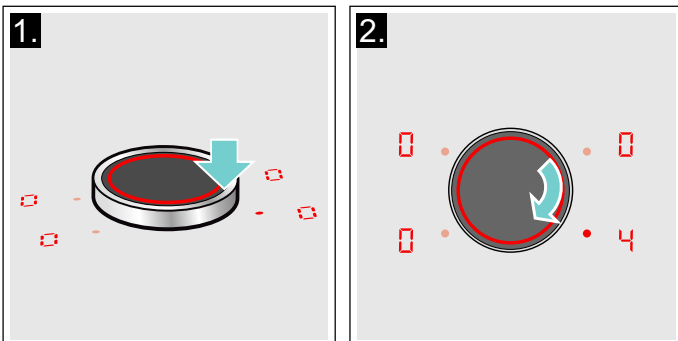

The heat setting is set.

Changing the heat setting

Select the hotplate and change the heat setting using the twist knob.

Switching off the hotplate

Select the hotplate and turn the twist knob until  appears. The hotplate switches itself off and the residual heat indicator lights up.

Notes

- If no pan has been placed on the hotplate, the selected power level flashes. After a certain time has elapsed, the hotplate switches off.
- If a pan has been placed on the hotplate before switching on the hob, it will be detected within 20 seconds of pressing the main switch and the hotplate will be selected automatically. Once detected, select the power level within the next 20 seconds or the hotplate will switch off. If more than one pan is placed on the hob, only one will be detected when switching it on.

Chef's recommendations

Recommendations

- When heating up puree, cream soups and thick sauces, stir occasionally.
- Set heat setting 8 to 9 for preheating.
- When cooking with the lid on, turn the heat setting down as soon as steam escapes between the lid and the cookware. Steam does not need to escape for a good cooking result.
- After cooking, keep the lid on the cookware until you serve the food.
- To cook with the pressure cooker, observe the manufacturer's instructions.
- Do not cook food for too long, otherwise the nutrients will be lost. The kitchen clock can be used to set the optimum cooking time.
- For a more healthy cooking result, smoking oil should be avoided.
- To brown food, fry small portions in succession.
- Cookware may reach high temperatures while the food is cooking. We recommend that you use oven gloves.
- You can find recommendations for energy-efficient cooking in section → "Environmental protection"

Cooking table

The table shows which heat setting is suitable for each type of food. The cooking time may vary depending on the type, weight, thickness and quality of the food.

	Heat setting	Cooking time (mins)
Melting		
Chocolate coating	1 - 1.	-
Butter, honey, gelatine	1 - 2	-
Heating and keeping warm		
Stew, e.g. lentil stew	1. - 2	-
Milk*	1. - 2.	-
Heating sausages in water*	3 - 4	-
Defrosting and heating		
Spinach, frozen	3 - 4	15 - 25
Goulash, frozen	3 - 4	35 - 55
Poaching, simmering		
Potato dumplings*	4. - 5.	20 - 30
Fish*	4 - 5	10 - 15
White sauces, e.g. Béchamel sauce	1 - 2	3 - 6
Whisked sauces, e.g. sauce béarnaise, hollandaise	3 - 4	8 - 12
Boiling, steaming, braising		
Rice (with double the volume of water)	2. - 3.	15 - 30
Rice pudding***	2 - 3	30 - 40
Unpeeled boiled potatoes	4. - 5.	25 - 35
Boiled potatoes	4. - 5.	15 - 30
Pasta, noodles*	6 - 7	6 - 10
Stew	3. - 4.	120 - 180
Soups	3. - 4.	15 - 60
Vegetables	2. - 3.	10 - 20
Vegetables, frozen	3. - 4.	7 - 20
Cooking in a pressure cooker	4. - 5.	-
Braising		
Roulades	4 - 5	50 - 65
Pot roast	4 - 5	60 - 100
Goulash***	3 - 4	50 - 60

* Without lid

** Turn several times

*** Preheat to heat setting 8 - 8.

	Heat setting	Cooking time (mins)
Roasting/frying with little oil*		
Escalope, plain or breaded	6-7	6-10
Escalope, frozen	6-7	8-12
Chop, plain or breaded**	6-7	8-12
Steak (3 cm thick)	7-8	8-12
Poultry breast (2 cm thick)**	5-6	10-20
Poultry breast, frozen**	5-6	10-30
Rissoles (3 cm thick)**	4.-5.	20-30
Hamburgers (2 cm thick)**	6-7	10-20
Fish and fish fillet, plain	5-6	8-20
Fish and fish fillet, breaded	6-7	8-20
Fish, breaded and frozen, e.g. fish fingers	6-7	8-15
Scampi, prawns	7-8	4-10
Sautéing fresh vegetables and mushrooms	7-8	10-20
Stir-fry, vegetables, meat cut in Asian-style strips	7-8	15-20
Frozen dishes, e.g. roasted dishes	6-7	6-10
Pancakes (baked in succession)	6.-7.	-
Omelette (cooked in succession)	3.-4.	3-6
Fried eggs	5-6	3-6
Deep-fat frying* (150-200 g per portion in 1-2 l oil, deep-fat fried in portions)		
Frozen products, e.g. chips, chicken nuggets	8-9	-
Croquettes, frozen	7-8	-
Meat, e.g. chicken portions	6-7	-
Fish, breaded or in beer batter	6-7	-
Vegetables, mushrooms, breaded or battered, tempura	6-7	-
Small baked items, e.g. doughnuts, fruit in batter	4-5	-
* Without lid		
** Turn several times		
*** Preheat to heat setting 8-8.		

Flex Zone

You can use each flex zone as a single hotplate or as two independent hotplates, as required.

It consists of four inductors that work independently of each other. If using the flexible cooking zone, only the area that is covered by cookware is activated.

Advice on using cookware

To ensure that the cookware is detected and heat is distributed evenly, correctly centre the cookware:

As a single hotplate

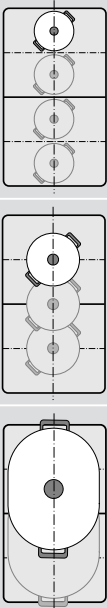

Diameter smaller than or equal to 13 cm
Place the cookware on one of the four positions that can be seen in the illustration.

Diameter greater than 13 cm
Place the cookware on one of the three positions that can be seen in the illustration.

If the cookware takes up more than one hotplate, place it starting on the upper or lower edge of the flexible cooking zone.

As two independent hotplates

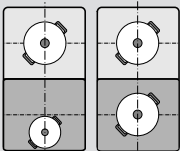

The front and rear hotplates each have two inductors and can be used independently of each other. Select the required heat setting for each of the hotplates. Use only one item of cookware on each hotplate.

Recommendations

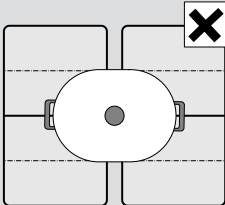

If the hob has more than one flexible cooking zone, place the cookware on top so that it covers only one of the flexible cooking zones. Otherwise, the hotplates will not be activated as intended and the cooking result will not be satisfactory.

As two independent hotplates

The flexible cooking zone is used like two independent hotplates.



Activating

See section → "Operating the appliance"

As a single hotplate

Using the entire cooking zone by connecting both hotplates.

Linking the two hotplates

1. Set down the cookware. Select one of the two hotplates in the flexible cooking zone and set the heat setting.
2. Touch the  symbol. The  indicator lights up. The flexible cooking zone is activated.

Note: The heat setting appears in the two displays for the flexible cooking zone.

Changing the heat setting

Select one of the two hotplates assigned to the flexible cooking zone and set the heat setting using the twist knob.

Adding new cookware

Set the new item of cookware down, select one of the two hotplates in the flexible cooking zone and then touch the  symbol twice. The new cookware is detected and the previously selected heat setting remains the same.

Note: If the cookware is moved to the hotplate being used or lifted up, the hotplate begins an automatic search and the heat setting selected previously is retained.

Disconnecting the two hotplates

Select one of the two hotplates assigned to the flexible cooking zone and touch the  symbol.

This deactivates the flexible cooking zone. The two hotplates will now function independently.

Note: If the hob is switched off, and then switched back on again later, the flexible cooking zone is reset to function as two independent hotplates.

Move function

This function activates the entire flexible cooking zone, which is divided into three cooking areas and which has preset heat settings.

Only use one item of cookware. The size of the cooking area depends on the cookware used and whether it is positioned correctly.

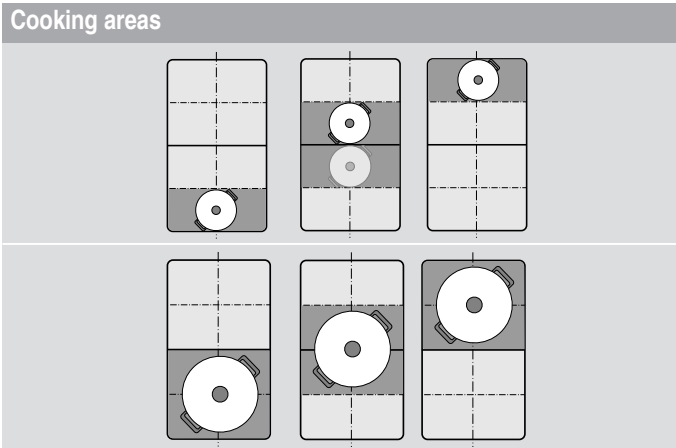

This means that an item of cookware can be moved during the cooking process to another cooking area with another heat setting:

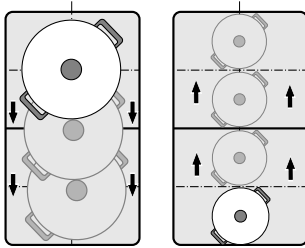

Preset heat settings:

Front area = heat setting **9**

Middle area = heat setting **5**



Rear area = heat setting **L**.

The preset heat settings can be changed independently of one another. You can find out how to change these in the section on → "Basic settings"

Notes

- If more than one item of cookware is detected on the flexible cooking zone, the function is deactivated.
- If the cookware is moved within the flexible cooking zone or lifted up, the hob automatically starts searching and the heat setting of the area in which the vessel was detected is set.
- You can find information on the size and positioning of the cookware in the section on → "Flex Zone"

Activation

1. Select one of the two hotplates in the flexible cooking zone.
2. Touch the  symbol. The indicator beside the  symbol lights up. The flexible cooking zone is activated as a single hotplate. The heat setting in the area in which the cookware is located lights up in the display for the front hotplate. The function has now been activated.

Changing the heat setting

The heat settings for the individual cooking areas can be changed during the cooking process. Set the cookware down on the cooking area and change the heat setting using the twist knob.

Notes

- Only the heat setting in the area in which the cookware is located is changed.
- If the function is deactivated, the heat settings for the three cooking areas are reset to the preset values.

Deactivating

Touch the  symbol. The indicator beside the  symbol goes out.

The function was deactivated.

Note: If one of the cooking areas is set to , the function deactivates after a few seconds.

FlexPlus Zone

The hob has two FlexPlus cooking zones which are located between the two flexible cooking zones and which switch on in conjunction with the right- or left-hand flexible cooking zone. This means that larger cooking vessels can be used and better cooking results can be achieved.

Each FlexPlus cooking zone always switches on in conjunction with the right- or left-hand flexible cooking zone. It is not possible to switch them on independently of one another.

Notes regarding cookware

The cookware should be positioned centrally for good thermal detection and distribution.

The cookware should cover the side hotplate and the FlexPlus cooking zone.

Depending on the size of the cookware, the flexible cooking zone can be activated as two independent hotplates or as one hotplate:

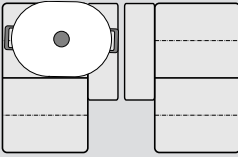
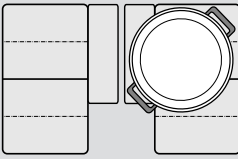
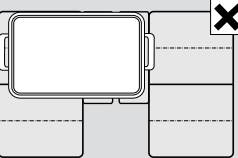
Set down the cookware	
	Elongated cookware: Activate the flexible cooking zone as two independent hotplates or as one hotplate.
	Large round cookware: Activate the flexible cooking zone as a single hotplate.
	The cookware must not cover both FlexPlus cooking zones at the same time.

Activation

1. Set down the cookware on the hotplate and make sure that it also covers the FlexPlus cooking zone.
2. Select the hotplate and the required heat setting. The hotplate and FlexPlus cooking zone indicators light up.

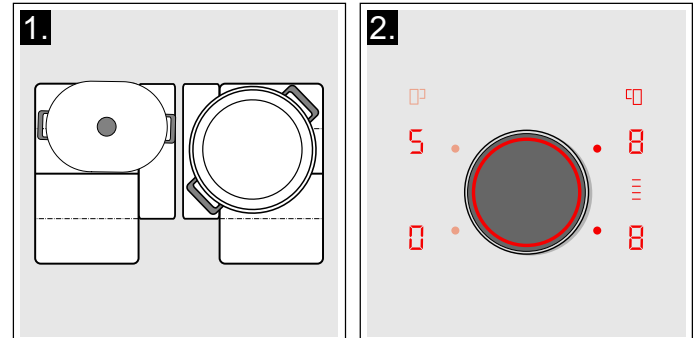

The flexible cooking zone is activated.

Deactivating

Remove the cookware from the hotplate. The displays go out.

This deactivates the FlexPlus cooking zone.

Time-setting options

Your hob has three timer functions:

- Programming the cooking time
- Kitchen timer
- Stopwatch function

Programming the cooking time

The hotplate automatically switches off after the time that is set has elapsed.

Setting procedure:

1. Select the hotplate and the required heat setting.
2. Touch the I→I symbol. The I→I display for the hotplate lights up. 00 lights up on the timer display.



3. Use the twist knob to select the required cooking time.



The cooking time begins to elapse.

Notes

- The same cooking time can be set automatically for all hotplates. The set time for each of the hotplates counts down independently. You can find information on automatically programming the cooking time in section → "Basic settings"
- If the flexible cooking zone is selected as the only hotplate, the set time for the entire cooking zone is the same.
- If the Move function is selected for the combined hotplate, the set time for the three hotplates is the same.

Frying sensor

If a cooking time has been programmed for a hotplate and the frying sensor has been activated, the cooking time will not begin to count down until the selected temperature setting has been reached.

Changing or deleting the time

Select the hotplate and then touch the I→I symbol.

Change the cooking time using the twist knob or on the control panel or set 00 to delete the programmed cooking time.

When the time has elapsed

The hotplate switches off. An audible signal sounds, 00 appears in the hotplate display and 00 appears in the timer display for one minute. The hotplate indicator I→I flashes. Touch any symbol; the indicators go out and the audible signal ceases.

Notes



- If a cooking time was programmed for several hotplates, the cooking time which ends first appears in the timer display. The I→I display for the hotplate lights up.
- Select the relevant hotplate to call up the remaining cooking time for a hotplate. The cooking time is displayed for 10 seconds.
- You can set a cooking time of up to 99 minutes.

The kitchen timer

You can use the kitchen timer to set a time of up to 99 minutes.

This functions independently from the hotplates and from other settings. This function does not automatically switch off a hotplate.

How to activate the function

1. Touch the  symbol: 00 and the — indicator appear in the timer display.
2. Use the twist knob to select the required time.
3. Touch the  symbol again to confirm the selected time.

The time begins to elapse.

Changing or deleting the time

Touch the  symbol and use the twist knob to change the time or set it to 00.

When the time has elapsed



An audible signal sounds for one minute and the 00 symbol flashes in the timer display. Touch the  symbol again: The displays go out and the audible signal ceases.

Stopwatch function

The stopwatch function displays the time that has elapsed since activation.

This functions independently from the hotplates and from other settings. This function does not automatically switch off a hotplate.

Activating

Touch the  symbol. The  symbol and the  indicator light up in the timer display.

The time begins to elapse.

Deactivating

Touch the  symbol.  appear in the timer display and then go out.

The function is deactivated.

Note: This function must be selected in order to deactivate the stopwatch.

PowerBoost function

The PowerBoost function enables you to heat up large quantities of water faster than when using heat setting .

This function can always be activated for a hotplate, provided the other hotplate in the same group is not in use (see illustration).

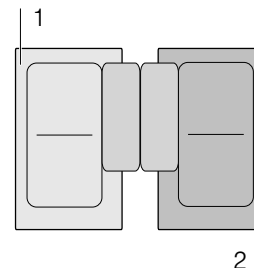





Note: The PowerBoost function can also be activated in the flexible area if the cooking zone is being used as a single hotplate.

Activating

1. Select a hotplate.
2. Touch the  symbol. The  and  indicators light up.

The function is activated.

Deactivating

1. Select a hotplate.
2. Touch the  symbol. The  and  indicators go out. The heat setting  lights up in the hotplate's display.

The function is deactivated.

Note: In certain circumstances, the PowerBoost function can switch itself off automatically in order to protect the electronic elements inside the hob.

ShortBoost function

The ShortBoost function enables you to heat cookware faster than when using heat setting 5.

After deactivating the function, select the appropriate heat setting for your food.

This function can always be activated for a hotplate, provided the other hotplate in the same group is not in use (see illustration).

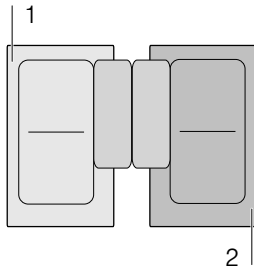



Note: With the flexible cooking zone, the ShortBoost function can be activated even if it is used as the only cooking zone.

Recommendations for use





- Always use cookware that has not been pre-heated.
- Use pots and pans with a flat base. Do not use cookware with a thin base.
- Never leave empty cookware, oil, butter or lard to heat up unattended.
- Do not place a lid on the cookware.
- Place the cookware on the centre of the hotplate. Ensure that the diameter of the base of the cookware corresponds to the size of the hotplate.
- You can find information on the type, size and positioning of the cookware in section → "Induction cooking"

Activating

1. Select a hotplate.
2. Touch the  symbol twice. The  and  indicators light up.

The function is activated.

Deactivating

1. Select a hotplate.
2. Touch the  symbol. The  and  displays go out. The heat setting  lights up in the display for the hotplate.



The function is deactivated.

Note: In certain circumstances, the ShortBoost function can switch itself off automatically in order to protect the electronic elements inside the hob.



Keep warm function

This function is suitable for melting chocolate or butter and for keeping food warm.

Activation

1. Select the required hotplate.
2. Touch the  within the next 10 seconds.  lights up on the display. The function is activated.

Deactivation

1. Select the hotplate.
2. Touch the  symbol. The  indicator goes out. The hotplate switches itself off and the residual heat indicator lights up. The function is deactivated.

Transferring settings

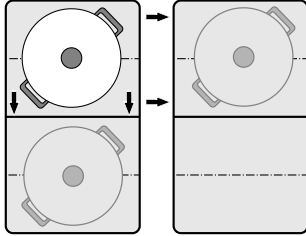

The heat setting and the programmed cooking time can be transferred from one hotplate to another using this function.

To transfer the settings, move the cookware from the hotplate which is switched on to another hotplate.



Note: You can find additional information on the positioning of the cookware in the section on → "Flex Zone"

Activation

1. Move the cookware from the hotplate which is switched on to another hotplate.
The heat setting of the original hotplate flashes. The cookware is detected and the previously selected heat setting and the  symbol flash in the new hotplate display.
2. Select the new hotplate to confirm the settings.
The heat setting of the original hotplate is set to .

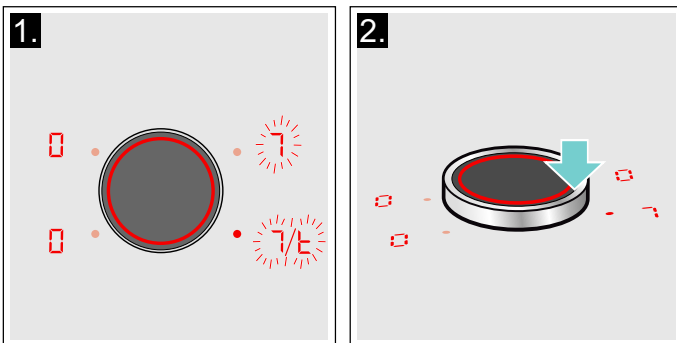

The function has now been activated.

The settings have been transferred to the new hotplate.

Notes

- Move the cookware to a hotplate which is not switched on, which you have not yet preset or on which no other cookware has been placed.
- The PowerBoost or ShortBoost function can then only be moved from left to right or right to left if no hotplate is active.
- If a new item of cookware is set down on another hotplate before the settings have been confirmed, this function is ready for both cooking vessels.
- If several vessels are moved, the function is only ready for the vessel which was last moved.

Frying Sensor

This function can be used to fry food while maintaining the suitable frying pan temperature.

The cooking zones that have this function are identified by the roasting function symbol.

Advantages when frying

- The hotplate only heats up if this is required to maintain the temperature. This saves energy and prevents the oil or fat from overheating.
- The frying function reports when the empty frying pan has reached the optimum temperature for adding oil and then for adding the food.

Notes

- Do not place a lid on the pan. Otherwise, the function does not activate correctly. You can use a splash guard to prevent splashes of grease.
- Use suitable oil or fat for frying. If butter, margarine, extra virgin olive oil or lard is used, set heat setting 1 or 2.
- Never leave a frying pan, with or without food, unattended when it is being heated.
- If the hotplate is a higher temperature than the cookware or vice versa, the frying sensor will not be activated correctly.

For frying with the frying sensor

Frying pans that are perfect for using with the frying sensor can be purchased from specialist retailers or through our technical after-sales service. Quote the relevant reference number:

- Z9451X0 15 cm frying pan.
- Z9452X0 19 cm frying pan.
- Z9453X0 21 cm frying pan.
- Z9455X0 28 cm frying pan. Only recommended for the FlexPlus cooking zone.

These frying pans have a non-stick coating so that you require only a small amount of oil to fry food.

Notes

- The frying sensor has been configured specifically for this type of frying pan.
- Ensure that the diameter of the base of the frying pan corresponds to the size of the hotplate. Put the frying pan in the centre of the hotplate.
- Using a frying pan of a different size or one that is poorly positioned on the flexible cooking zones may result in the frying sensor not being activated. See the section on → "Flex Zone".
- Other frying pans may overheat. They may reach a temperature above or below the selected temperature setting. Try the lowest temperature setting to begin with and change it if necessary.

Temperature settings

Temperature setting	Suitable for
1	Very low
2	Low
3	Medium - low
4	Medium - high
5	High

Table

The table shows which heat setting is suitable for each type of food. The roasting time may vary depending on the type, weight, size and quality of the food.

The set heat setting varies depending on the frying pan that is used.



Preheat the empty pan; add oil and food after the acoustic signal has sounded.

	Temperature setting	Total frying time after the signal sounds (mins.)
Meat		
Escalope, plain or breaded	4	6 - 10
Fillet	4	6 - 10
Chops*	3	10 - 15
Cordon bleu, Viennese Schnitzel*	4	10 - 15
Steak, rare (3 cm thick)	5	6 - 8
Steak, medium or well-done (3 cm thick)	4	8 - 12
Poultry breast (2 cm thick)*	3	10 - 20
Sausages, pre-boiled or raw*	3	8 - 20
Hamburger, meatballs, rissoles*	3	6 - 30
Stripes of meat, gyros	4	7 - 12
Minced meat	4	6 - 10
Bacon	2	5 - 8
Fish		
Fish, fried, whole, e.g. trout	3	10 - 20
Fish fillet, plain or breaded	3 - 4	10 - 20
Prawns, scampi	4	4 - 8
Egg dishes		
Pancakes**	5	1,5 - 2,5
Omelette**	2	3 - 6
Fried eggs	2 - 4	2 - 6
Scrambled eggs	2	4 - 9
Shredded raisin pancake	3	10 - 15
French toast**	3	4 - 8
* Turn several times.		
** Total cooking time per portion. Fry in succession.		

	Temperature setting	Total frying time after the signal sounds (mins.)
Potatoes		
Fried potatoes (boiled in their skin)	5	6 - 12
Fried potatoes (made from raw potatoes)	4	15 - 25
Potato pancakes**	5	2,5 - 3,5
Swiss rösti	2	50 - 55
Glazed potatoes	3	15 - 20
Vegetables		
Garlic, onions	1 - 2	2 - 10
Courgettes, aubergines	3	4 - 12
Peppers, green asparagus	3	4 - 15
Vegetables sautéed in oil, e.g. courgettes, green peppers	1	10 - 20
Mushrooms	4	10 - 15
Glazed vegetables	3	6 - 10
Onion rings	3	5 - 10
Frozen products		
Escalope	4	15 - 20
Cordon bleu*	4	10 - 30
Poultry breast*	4	10 - 30
Chicken nuggets	4	10 - 15
Gyros, kebab	4	10 - 15
Fish fillet, plain or breaded	3	10 - 20
Fish fingers	4	8 - 12
French fries	5	4 - 6
Stir-fries meals, e.g. fried vegetables with chicken	3	6 - 10
Spring rolls	4	10 - 30
Camembert/cheese	3	10 - 15
Sauces		
Tomato sauce with vegetables	1	25 - 35
Béchamel sauce	1	10 - 20
Cheese sauce, e.g. Gorgonzola sauce	1	10 - 20
Reducing sauces, e.g. tomato sauce, Bolognese sauce	1	25 - 35
Sweet sauces, e.g. orange sauce	1	15 - 25
Miscellaneous		
Camembert/cheese	3	7 - 10
Dry ready meals that require water to be added, e.g. pasta	1	5 - 10
Croutons	3	6 - 10
Almonds/walnuts/pine nuts	4	3 - 15
* Turn several times.		
** Total cooking time per portion. Fry in succession.		

Setting procedure

Select the appropriate temperature setting from the table. Place the empty frying pan on the hotplate.

1. Select the hotplate and touch the  symbol.  lights up in the hotplate display.

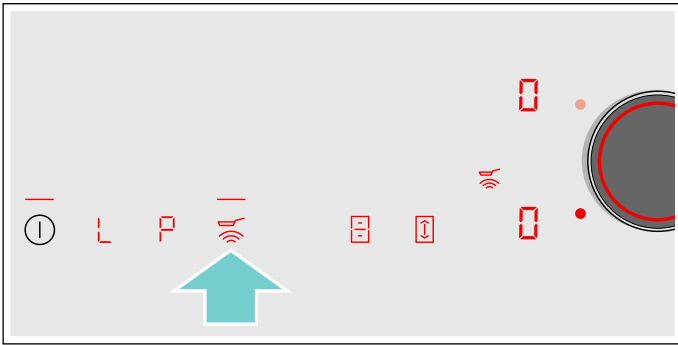

2. Within the next 5 seconds, select the required temperature setting using the twist knob.

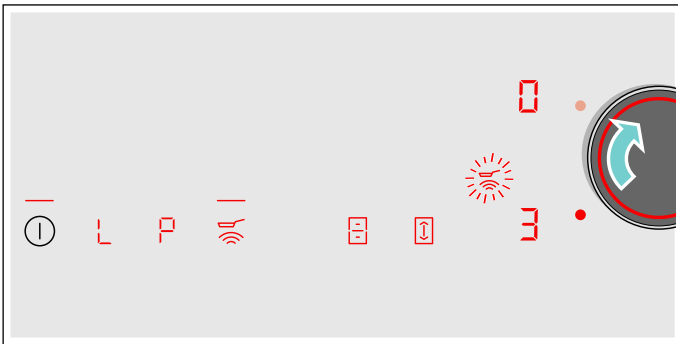

The function has now been activated.

The  temperature symbol flashes until the frying temperature is reached. A signal sounds and the temperature symbol lights up.

3. Once the frying temperature has been reached, add the fat and then the food to the pan.

Note: Turn the food so that it does not burn.

Switching off the frying sensor



Select the hotplate and touch the  symbol. The function is deactivated.

Childproof lock

You can use the childproof lock to prevent children from switching on the hob.

Activating and deactivating the childproof lock

The hob must be switched off.

To activate: Touch the  symbol for approx. 4 seconds. The  indicator lights up for 10 seconds. The hob is locked.

To deactivate: Touch the  symbol for approx. 4 seconds. The lock is released.

Childproof lock

With this function, the childproof lock automatically activates when a hob is switched off.

Switching on and off

You can find out how to switch the automatic childproof lock on in the → *"Basic settings"* section



Wipe protection

Wiping over the control panel while the hob is switched on may alter the settings. To avoid doing this, you can use the hob's "Lock control panel for cleaning" function.

To activate this function: Remove the twist knob. The  indicator will be lit. The control panel will remain locked for 35 seconds. You will now be able to clean the surface of the control panel without altering the settings.

To deactivate this function: The control panel will be unlocked once 35 seconds have elapsed. To end the function early, fit the twist knob back on and turn it until the  indicator goes out.

Notes

- The timer displays the time that has elapsed since the lock was activated. An audible signal sounds 30 seconds after activation. This indicates that the function is about to finish.
- The cleaning lock does not lock the main switch. The hob can be switched off at any time.



Automatic safety cut-out

If a hotplate operates for an extended period and no settings are changed, the automatic safety shut-off is activated.

The hotplate stops heating. **F**, **B** and the residual heat indicator **h** or **H** flash alternately in the hotplate display.

When you touch any symbol, the display switches off. The hotplate can now be set again.

The point at which the safety shut-off becomes active depends on which heat setting has been set (after 1 to 10 hours).

Basic settings

The appliance has various basic settings. You can adapt these to suit your cooking habits.

Display	Function
c 1	Automatic childproof lock 0 Manual*. 1 Automatic. 2 Function deactivated.
c 2	Audible signals 0 Confirmation and fault signals are switched off. 1 Only the fault signal is switched on. 2 Only the confirmation signal is switched on. 3 All signal tones are switched on.*
c 3	Display energy consumption 0 Switched off.* 1 Switched on.
c 5	Automatically programming the cooking time 00 Switched off.* 0 1-99 Time until automatic switch-off.
c 6	Duration of the timer-end signal tone 1 10 seconds. 2 30 seconds. 3 1 minute.*
c 7	Power management function. Limiting the total power of the hob 0 Switched off.* 1 1000 W minimum power. 1. 1500 W. 2 2000 W. ... 9 or 9. Maximum power of the hob.
c 9	Time for selecting the hotplate 0 Unlimited: The hotplate which was set last remains selected.* 1 Limited: The hotplate only remains selected for a few seconds.
c 11	Changing the preset heat settings for the Move function _9 Preset heat setting for the front cooking zone. -5 Preset heat setting for the central cooking zone. -L Preset heat setting for the rear cooking zone.
c 12	Checking cookware and cooking results 0 Not suitable 1 Not perfect 2 Suitable

* Factory settings

Display	Function
	Restoring the factory settings
	Individual settings.*
	Restore factory settings.

* Factory settings

To access the basic settings:

The hob must be off.

1. Switch on the hob.
2. Within ten seconds, touch and hold the symbol for approximately three seconds.
The first four displays provide product information.
Turn the twist knob to view the individual displays.

Product information	Display screen
After-sales service index (ASSI)	
Production number	
Production number 1	
Production number 2	

3. Touch the symbol again to access the basic settings.
 and light up as a presetting in the displays.

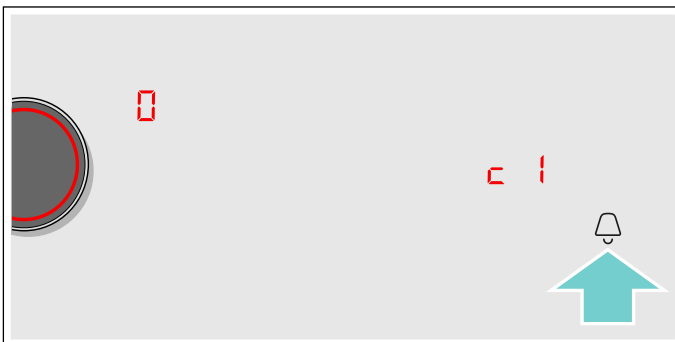

4. Touch the symbol repeatedly until the required function is displayed.
5. Then use the twist knob to select the required setting.

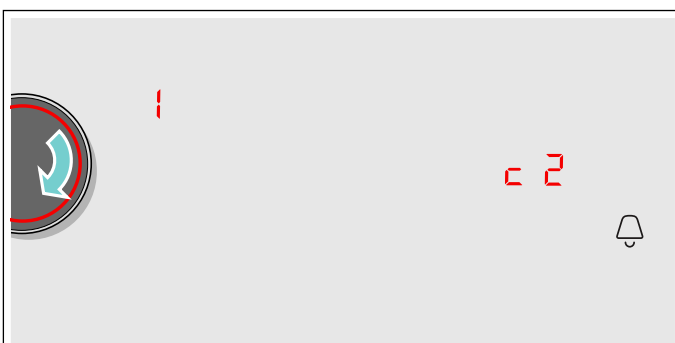

6. Touch the symbol for at least three seconds.
The settings have been saved.

Leaving the basic settings

Turn off the hob with the main switch.

Energy consumption indicator

This function indicates the total amount of energy consumed by this hob the last time it was used for cooking.

Once switched off, the energy consumption in kWh is displayed for 10 seconds.

The picture shows an example with an energy consumption of **1.08 kWh**.



You can find out how to switch this function on in the section on → *"Basic settings"*

Cookware check

This function can be used to check the speed and quality of the cooking process depending on the cookware.



The result is a reference value and depends on the properties of the cookware and the hotplate being used.

1. With the cookware still cold, fill it with approx. 200 ml of water and place it on the centre of the hotplate with the diameter that most closely matches that of the base of the cookware.
2. Go to the basic settings and select the **c 12** setting.
3. Turn the twist knob. **—** flashes on the hotplate displays.
The function is activated.

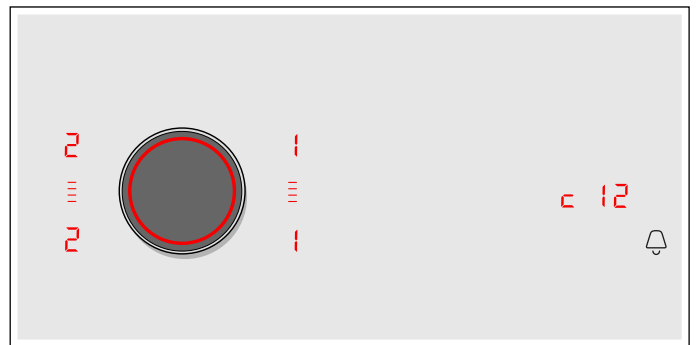
After 10 seconds, information on the quality and speed of the cooking process appears in the hotplate displays.



Check the result using the following table:

Result	
	The cookware is not suitable for the hotplate and will therefore not heat up.*
	The cookware is taking longer to heat up than expected and the cooking process is not going as well as it should.*
	The cookware is heating up correctly and the cooking process is going well.
* If there is a smaller hotplate available, test the cookware again on the smaller hotplate.	

To reactivate the function, turn the twist knob.

Notes

- The flexible cooking zone only counts as a single hotplate; place no more than one item of cookware on it.
- If the diameter of the hotplate used is much smaller than the diameter of the cookware, only the middle of the cookware can be expected to heat up. This may result in the cooking results not being as good as expected or being less than satisfactory.
- You can find information on this function in the section on → *"Basic settings"*.
- You can find information on the type, size and positioning of the cookware in the sections on → *"Induction cooking"* and → *"Flex Zone"*.

Home Connect

Note: Home Connect is due to be introduced for NEFF from the end of 2018.

This appliance is WLAN-enabled and settings can be sent to the appliance via a mobile device.

If the appliance is not connected to the home network, the appliance functions in the same way as a hob with no network connection. The hob can always be operated via the control panel.

The availability of the Home Connect function depends on the availability of Home Connect services in your country. Home Connect services are not available in every country. You can find more information on this at www.home-connect.com.

Notes

- Hobs are not designed to be used unattended - you must always keep an eye on the cooking process.
- Ensure that you follow the safety instructions in this instruction manual and that these are also observed when operating the appliance via the Home Connect app. You must also follow the instructions in the Home Connect app. → "Important safety information" on page 6
- Using the Home Connect app, you can send settings to your appliance and then have to confirm them on the appliance. It is not possible to operate the appliance whilst you are away from home.
- Operation on the appliance always has priority. During this time, it is not possible to operate the appliance using the Home Connect app.

Setting up

To implement settings via Home Connect, you must have installed and set up the Home Connect app on your mobile device.



Follow the steps specified by the app to make the settings.

The app must be open in order to perform the setup process.



Automatic registration in the home network

You require a router that has WPS functionality.

You require access to your router. If you do not have this, follow the steps for "Manual registration in the home network".

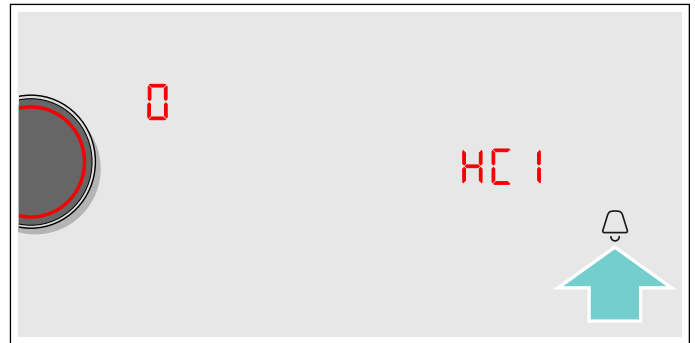
1. Touch the  symbol for 3 seconds. Product information will be displayed.
2. Touch the  symbol repeatedly until the **HC 1** setting appears.



3.  lights up in the cooking position display.
3. Set the value to **1** using the twist knob. **1** and the  symbol will flash on the cooking position display.
4. Press the WPS button on the router within the next 2 minutes. The hob is connected to the home network if the  symbol no longer flashes but is lit up on the cooking position display.

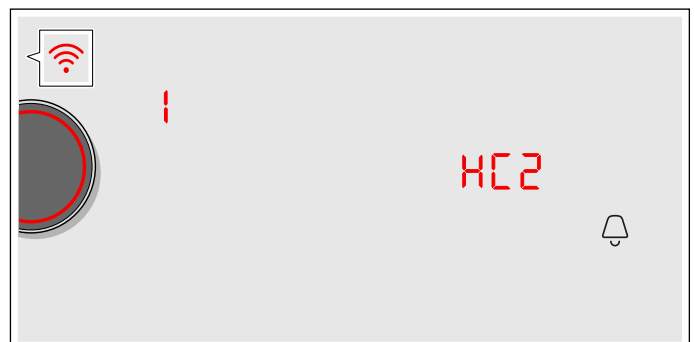

Note: If a connection cannot be established, the "Connect manually"  value appears. Register the appliance in the home network manually or try connecting automatically again.

The appliance automatically tries to connect to the app; the **HC 2** setting appears. The **1** value flashes on the control panel.



5. On your mobile device, follow the instructions in the app for automatic network registration. The registration procedure has been completed once the  value appears in the cooking position display.

Manual registration in the home network

1. Touch the  symbol for 3 seconds.
Product information will be displayed.
2. Touch the  symbol repeatedly until the **HC 1** setting appears.
 lights up in the cooking position display.

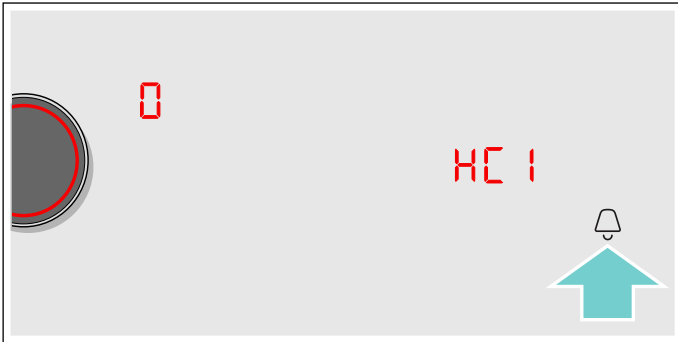

3. Set the value to **2** using the twist knob.
2 and the  symbol will flash on the cooking position display.

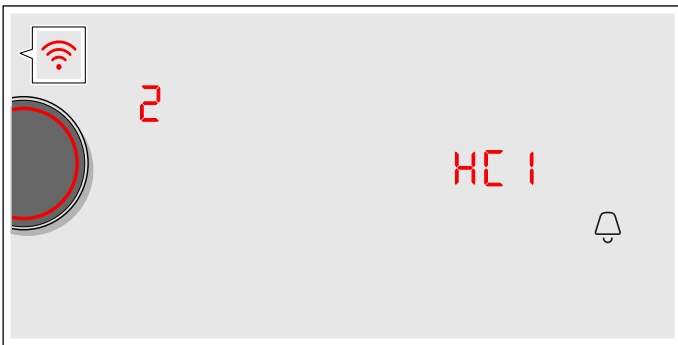

4. Use the "Home Connect" SSID and the "Home Connect" key to register the mobile device on the hob network.

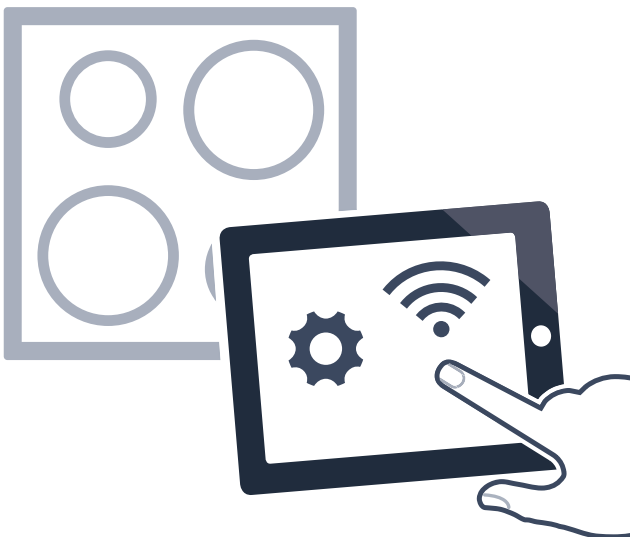

The hob is connected to the home network if the  symbol no longer flashes but is lit up on the cooking position display.
The appliance automatically tries to connect to the app; the **HC2** setting appears. The **1** value flashes on the control panel.

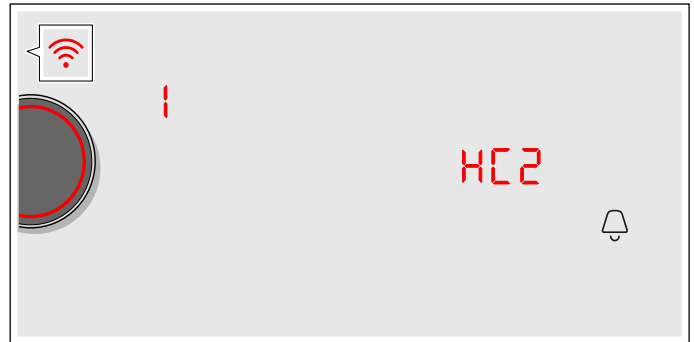

5. Start the app on the mobile device and follow the instructions for manual network registration.
The registration procedure has been completed once the  value appears in the cooking position display.

Home Connect settings

You can adjust Home Connect to suit your requirements at any time.

In the basic settings for your hob, navigate to the Home Connect settings to display network and appliance information.

Symbol	Function
HC 1	Registration in the home network (WLAN)
0	Not connected /disconnect network.
1	Connect automatically.
2	Connect manually.
3	Connected.
HC 2	Connection to app
0	Not connected.
1	Connect.
HC 3	Connect to WLAN
0	Radio module switched off.
1	Radio module switched on.
HC 4	Settings via app
0	Switched off.
1	Switched on.*
HC 5	Software update
1	Update available and ready for installation.
2	Starting installation.
* Basic setting	

Symbol	Function
HCB	Remote access by Customer Service
0	Not permitted.
1	Permitted.
HC7	WLAN signal strength
0	Not connected to home network (WLAN).
1	Signal strength 1 (poor)
2	Signal strength 2 (moderate)
3	Signal strength 3 (good)
HCB	Connection to Home Connect server
0	Not connected.
1	Connected.
* Basic setting	



Notes

- The **HC2** setting is only displayed if the appliance is connected to the home network.
- The **HC3** setting is only displayed if the appliance has once connected to a network.
- The **HC5** setting is only displayed if an update is available.
- The **HCB** setting is only displayed if Customer Service is attempting to connect to the appliance. You can end this at any time after granting access.
- The **HC7** and **HCB** settings are only displayed if there is a connection to WLAN.

Deactivating WLAN

If WLAN is activated, you can use the Home Connect functions.

Note: In networked standby mode, your appliance requires max. 2 W.

1. Touch the  symbol for 3 seconds. Product information will be displayed.
2. Touch the  symbol repeatedly until the **HC3** setting appears. **1** lights up in the cooking position display.





3. Set the value to **0** using the twist knob. WLAN is deactivated and the  symbol on the control panel goes out.

Disconnecting from the network



You can disconnect your hob from the network at any time.

Note:

If your hob is disconnected from the network, it is not possible to operate it using Home Connect.

1. Touch the  symbol for 3 seconds. Product information will be displayed.
2. Touch the  symbol repeatedly until the **HC1** setting appears. **3** lights up in the cooking position display.
3. Set the value to **0** using the twist knob. The appliance is disconnected from the home network and the  symbol on the control panel goes out.

Connecting to the network

1. Touch the  symbol for 3 seconds. Product information will be displayed.
2. Touch the  symbol repeatedly until the **HC1** setting appears. **0** lights up in the cooking position display.

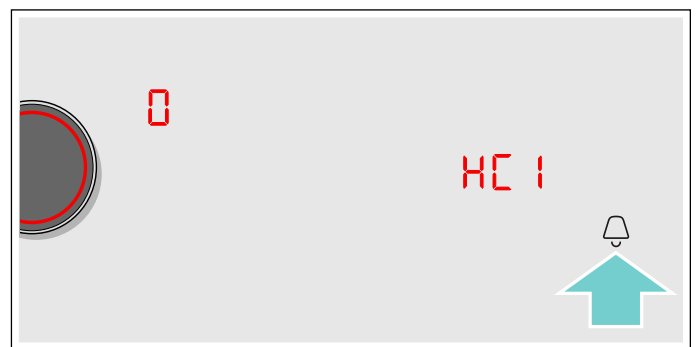

3. Using the twist knob, set the "Connect automatically" **1** value or the "Connect manually" **2** value.
4. Follow the instructions in the section entitled "Automatic registration in the home network" or "Manual registration in the home network".



Connect to the app

If the Home Connect app is installed on your mobile device, you can connect it to your hob.

Notes

- The appliance must be connected to the network.
- The app must be open and be set up.
- There is a direct connection to an extractor hood, first disconnect the hob from the home network and start the connection again.

1. Touch the  symbol for 3 seconds. Product information will be displayed.

2. Touch the  symbol repeatedly until the **HC2** setting appears.
 lights up in the cooking position display.

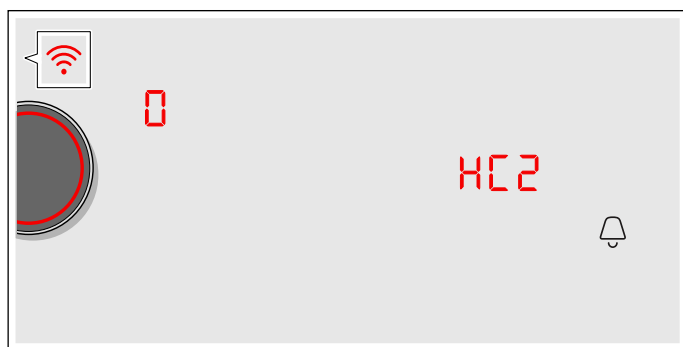



3. Set the value to **!** using the twist knob.
4. Follow the instructions in the app to complete the connection process.

Settings via app

Using the Home Connect app, you can easily access the basic settings for your hob and send settings for the cooking positions to the hob.

Notes

- To change basic settings the hob must be switched off.
 - Operation on the appliance always has priority. During this time it is not possible to operate the appliance using the Home Connect app.
 - The transfer of settings is activated when the appliance is supplied.
 - If the transfer of settings has been deactivated, only the hob's operating statuses will be displayed in the Home Connect app.
1. Touch the  symbol for 3 seconds. Product information will be displayed.
 2. Touch the  symbol repeatedly until the **HC4** setting appears.
 3. To activate transfer, select the **!** value with the twist knob. To deactivate transfer, select the  value.

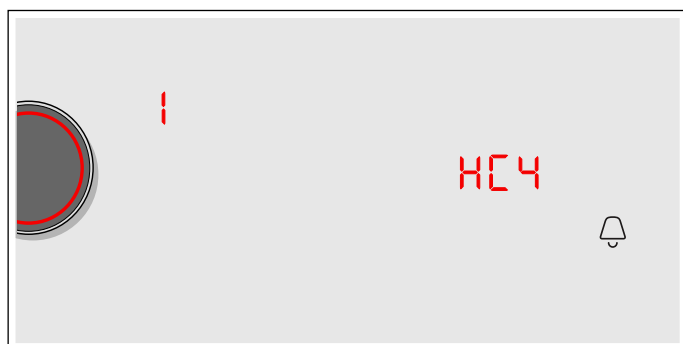

Confirming settings

As soon as cooking settings are transmitted to a cooking position, its display starts to flash. To confirm these settings, touch the twist knob in the appropriate area for the cooking position required. To discard the settings, touch any other button on the hob.

Software update

Using the software update function, your hob's software can be updated (e.g. for the purpose of optimisation, troubleshooting or security updates). To do this, you need to be a registered Home Connect user, have installed the app on your mobile device and be connected to the Home Connect server.

As soon as a software update is available, you will be informed by the Home Connect app, from which you will also be able to download the update.

Once the update has been successfully downloaded, you can start installing it via the hob (basic settings, **HC5** setting) or the Home Connect app if you are on your local area network.

The Home Connect app will notify you once installation is complete.

Notes

- You can continue to use your hob as normal while updates are downloading.
- Depending on your personal settings in the app, software updates can also be set to download automatically.
- We recommend that you install security updates as soon as possible.

About data protection

When your appliance is connected for the first time to a WLAN network, which is connected to the Internet, your appliance transmits the following categories of data to the Home Connect server (initial registration):

- Unique appliance identification (consisting of appliance codes as well as the MAC address of the installed WiFi communication module).
- Security certificate of the WiFi communication module (to ensure a secure IT connection).
- The current software and hardware version of your domestic appliance.
- Status of any previous resetting to factory settings.

This initial registration prepares the Home Connect functions for use and is only required when you want to use these Home Connect functions for the first time.

Note: Ensure that the Home Connect functions can be used only in conjunction with the Home Connect app. Information on data protection can be accessed in the Home Connect app.

Declaration of Conformity

Constructa Neff Vertriebs-GmbH hereby declares that the appliance with functionality meets the basic requirements and other relevant provisions of Directive 2014/53/EU.

A detailed RED Declaration of Conformity can be found online at banyo.co.uk among the additional documents on the product page for your appliance.



Hood connection

You can connect this appliance to a suitable extractor hood and control the functions of the hood via your hob.

There are various options for connecting the appliances together:

Home Connect

Two appliances can be connected using the Home Connect app provided that both of them are Home Connect-compatible.

Observe the supplied Home Connect documents for this.



Connecting appliances directly

If the appliance is directly connected to a cooker hood, connection to the home network is no longer possible. The appliance functions in the same way as a hob with no network connection. The hob can always be operated via the control panel.

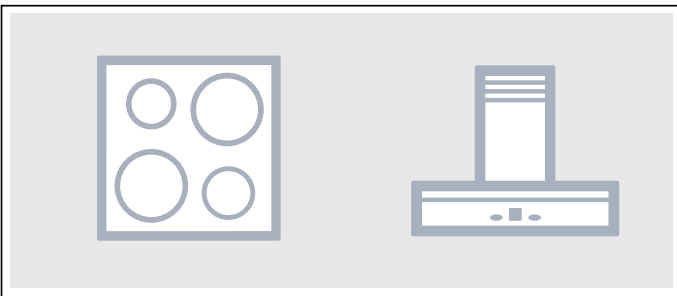

Connecting appliances via the home network

If the appliances are connected to each other via your home network, both the hood controls and Home Connect can be used to operate the hob.

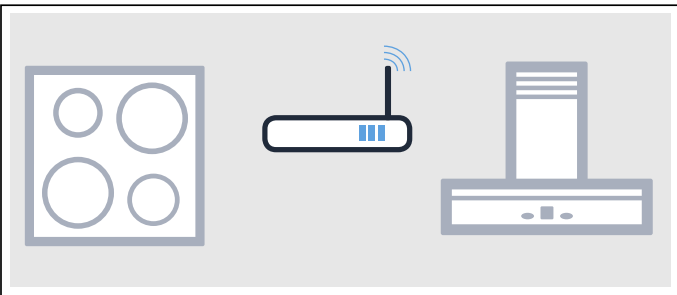

Notes

- Make sure you follow the safety instructions in the instruction manual for your extractor hood and that these are also observed when operating the appliance via the hood controls on the hob. → "Important safety information" on page 6
- Using the controls on the extractor hood always takes priority. It is not possible to use the hood controls on the hob during this time.
- In networked standby mode, your appliance requires max. 2 W.







Setting up

Both the hob and the extractor hood must be switched on before you can connect them to each other.

To do this, refer to the section entitled "Connecting to the hob" in the instruction manual for your extractor hood.

Connecting directly

If you connect your hob directly to the extractor hood, it cannot be connected to the home network as well and you will not be able to use Home Connect any longer.

1. Touch the  symbol for 3 seconds.
2. Touch the  symbol repeatedly until the  setting appears.
 lights up in the cooking position display.
3. Set the value to  using the twist knob.
 lights up in the cooking position display.
4. Start the connection to the extractor hood within the next 2 minutes.







The hob is connected to the extractor hood when the  value appears on the cooking position display. The symbols for the hood controls on the hob are displayed on the hob's control panel.

Connecting via your home network

You require a router that has WPS functionality.

You require access to your router. If you do not have this, follow the steps for "Direct connection".



First of all make sure that the extractor hood is in the home network.

1. Touch the  symbol for 3 seconds.
2. Touch the  symbol repeatedly until the  setting appears.
 lights up in the cooking position display.
3. Set the value to  using the twist knob.
 will flash on the cooking position display.
4. Press the WPS button on the router within the next 2 minutes.
When the connection to the home network has been established, the hob automatically connects to the extractor hood.
5. Connect to the extractor hood.
The connection process has been completed once the  value appears on the cooking position display. The symbols for the hood controls on the hob are displayed on the hob's control panel.

Note: The connection can only be established when both appliances are connected to your home network and are engaged in connection. If the connection process has already timed out for one of the two appliances, try to connect again (basic settings, **c 16** setting).

Resetting connection

You can reset the connections saved for your home network and extractor hood at any time.

1. Touch the  symbol for 3 seconds.
2. Touch the  symbol repeatedly until the **c 16** setting appears.
3. Set the value to  using the twist knob.

Control the hood via the hob

In the basic settings of your hob you can adjust the behaviour of your extractor hood depending on the switch-on/off of the hob or individual cooking zones. → "Hood control settings" on page 35

You can select other settings using the control panel.

Setting the fan

Switching on

Touch the  symbol.

Setting fan level

Use the twist knob to select the fan setting.

You can choose between the levels 1, 2 and 3. To select the intensive levels, turn the twist knob until **P 1** or **P 2** appears.

Switching off

Use the twist knob to select fan setting 0.

Setting automatic mode

Switching on

1. Touch the  symbol.
2. Turn the twist knob until the **A** symbol appears on the control panel.
The fan starts up automatically when steam is produced.

Switching off

1. Touch the  symbol.
2. Turn the twist knob until the fan setting 0 has been selected or choose another fan setting.

Setting the hood lighting

You can switch the hood light on and off via the hob's control panel.

Touch the  symbol.

Hood control settings

You can adapt the hood controls to suit your needs at any time.

Symbol	Function
c 16	Hob-hood connection
0	Not connected / disconnect.
1	Connect.
2	Connected to home network (WLAN).
3	Connected to extractor hood.
c 18	Automatic fan switch-on
0	Switched off. The hood must be switched on manually if needed.
1	Switched on in automatic mode.* In automatic mode, the hood switches itself on when a cooking zone is switched on.
2	Switched on in manual mode. The hood switches itself on with a default setting when a cooking zone is switched on.
c 20	Fan run-on
0	The fan switches itself off when the hob is switched off.
1	Switched on in automatic mode.*
2	Switched on with standard fan run-on.
3	No change in settings.
c 21	Switch light on automatically
0	Switched off.
1	Switched on.* The light switches itself on when the hob is switched on.
c 22	Switch light off automatically
0	Switched off.*
1	Switched on. The light switches itself off when the hob is switched off.
* Basic setting	

Note: The **c 18**, **c 20**, **c 21** and **c 22** settings are only displayed if the appliance is connected to an extractor hood.

Cleaning

Suitable maintenance and cleaning products can be purchased from the after-sales service or in our e-Shop.

Hob

Cleaning

Always clean the hob after cooking. This will prevent food deposits from becoming burned on. Only clean the hob after the residual heat indicator has gone out.

Clean the hob with a damp dish cloth and dry it with a cloth or towel to prevent limescale build-up.

Only use cleaning agents that are suitable for this type of hob. Observe the manufacturer's instructions on the product packaging.

Never use:

- Undiluted washing-up liquid
- Cleaning agents designed for dishwashers
- Abrasive cleaners
- Harsh cleaning agents, such as oven spray and limescale remover
- Scouring pads
- High-pressure cleaners or steam jet cleaners

Stubborn dirt is best removed with a glass scraper, available from retailers. Observe the manufacturer's instructions.

You can obtain a suitable glass scraper from customer services or through our online shop.

Using a special sponge for cleaning glass-ceramic hobs achieves a great cleaning result.

Potential marks	
Limescale and water marks	Clean the hob as soon as it has cooled down. You can use a cleaning agent suitable for glass-ceramic hobs.*
Sugar, rice starch or plastic	Clean immediately. Use a glass scraper. Caution: Risk of burns.*
* Then clean with a damp dish cloth and dry with a cloth or towel.	

Note: Do not use any cleaning agents while the hob is still hot. This may mark the surface. Make sure that any residue left by cleaning agents is removed.

Hob surround

To prevent damage to the hob surround, observe the following instructions:

- Only use warm soapy water
- Wash new dish cloths thoroughly before use.
- Do not use harsh or abrasive cleaning agents.
- Do not use a glass scraper or sharp objects.

Twist knob

The twist knob is best cleaned using lukewarm soapy water. Do not use harsh or abrasive cleaning agents. Do not clean the twist knob in the dishwasher or using rinsing water. This may damage it.

Frequently Asked Questions (FAQ)

Using the appliance

Why can't I switch on the hob and why is the childproof lock symbol lit?

The childproof lock is activated.
You can find information on this function in the section on → "*Childproof lock*"

Why are the displays flashing and why can I hear an audible signal?

Remove any liquid or food remains from the control panel. Remove any objects from the control panel.
You can find instructions on how to deactivate the audible signal in the section on → "*Basic settings*"

Noises

Why I can hear noises while I'm cooking?

Noises may be generated while using the hob depending on the base material of the cookware. These noises are a normal part of induction technology. They do not indicate a defect.

Possible noises:

A low humming noise like the one a transformer makes:

Occurs when cooking at a high heat setting. The noise disappears or becomes quieter when the heat setting is reduced.

Low whistling noise:

Occurs when the cookware is empty. This noise disappears when water or food is added to the cookware.

Crackling:

Occurs when using cookware made from different layers of material or when using cookware of different sizes and different materials at the same time. The loudness of the noise can vary depending on the quantity of food being cooked or the cooking method.

High-pitched whistling noises:

Can occur when two hotplates are used at the highest heat setting at the same time. The whistling noises disappear or become quieter when the heat setting is reduced.

Fan noise:

The hob is equipped with a fan that switches on automatically at high temperatures. The fan may continue to run even after you have switched off the hob if the temperature detected is still too high.

Cookware

Which types of cookware can be used with an induction hob?

You can find information on which types of cookware can be used with an induction hob in the section on → "*Induction cooking*".

Why is the hotplate not heating up and why is the heat setting flashing?

The hotplate on which the cookware is standing is not switched on.
Check that you have switched on the correct hotplate.

The cookware is too small for the hotplate that is switched on or it is not suitable for induction cooking.

Check that the cookware is suitable for induction cooking and that it is placed on the hotplate that best corresponds to its size. You can find information on the type, size and positioning of cookware in the sections on → "*Induction cooking*", → "*Flex Zone*" and → "*Move function*".

Why is it taking so long for the cookware to heat up or why is it not heating up sufficiently despite being on a high heat setting?

The cookware is too small for the hotplate that is switched on or it is not suitable for induction cooking.

Check that the cookware is suitable for induction cooking and that it is placed on the hotplate that best corresponds to its size. You can find information on the type, size and positioning of cookware in the sections on → "*Induction cooking*", → "*Flex Zone*" and → "*Move function*".

Cleaning

How do I clean the hob?

Using a special glass-ceramic cleaning agent produces the best results. We advise against using harsh or abrasive cleaning agents, dishwasher detergent (concentrated) or scouring pads.

You can find more information on cleaning and caring for your hob in the section on → "Cleaning"

Trouble shooting

Usually, faults are small matters that are easy to eliminate. Please read the information in the table before calling the after-sales service.

Display	Possible cause	Solution
None	The power supply has been disconnected. The device has not been connected in accordance with the circuit diagram. Electronics fault.	Use other electrical devices to check whether a short-circuit has occurred in the power supply. Ensure that the device has been connected in accordance with the circuit diagram. If the fault cannot be eliminated, inform the technical after-sales service.
The displays flash	The control panel is damp or an object is covering it.	Dry the control panel or remove the object.
The – indicator flashes in the hotplate displays	A fault has occurred in the electronics.	To acknowledge the fault, cover the control panel with your hand.
F2	The electronics have overheated and have switched off the corresponding hotplate.	Wait until the electronics have cooled down sufficiently. Then touch any symbol on the hob.
F4	The electronics have overheated and have switched off all hotplates.	
F5 + heat setting and acoustic signal	There is a hot pan in the area of the control panel. There is a risk that the electronics will overheat.	Remove the pan. The fault display goes out shortly afterwards. You can continue to cook.
F5 and acoustic signal	There is a hot pan in the area of the control panel. To protect the electronics, the hotplate has been switched off.	Remove the pan. Wait for a few seconds. Touch any control. If the fault display goes out, you can continue to cook.
F1/F6	The hotplate has overheated and switched itself off to protect the work surface.	Wait until the electronics have cooled down sufficiently and switch the hotplate on again.
F0	You cannot activate the settings transfer function	Check the fault display by touching any control. You can cook as usual without using the settings transfer function. Contact the technical after-sales service.
F9	You cannot activate the FlexPlus cooking zone	Check the fault display by touching any control. You can use the remaining hotplates to cook as usual. Contact the technical after-sales service.
F8	The hotplate was operating for an extended period without interruption.	The automatic safety switch-off function has been activated. See section
E9000 E9010	The supply voltage is faulty; outside of the normal operating range.	Contact your electricity provider.
U400	The hob is not connected properly	Disconnect the hob from the power supply. Ensure that it has been connected in accordance with the circuit diagram.
dE	The demo mode is activated	Disconnect the hob from the power supply. Wait 30 seconds and reconnect it. Touch any touch control in the next three minutes. The demo mode is deactivated.

Do not place hot pans on the control panel.

Notes

- If **E** appears on the display, the Twist knob for the burner in question must be held down in order to be able to read off the fault code.
- If the fault code is not listed in the table, disconnect the hob from the power supply and wait 30 seconds before reconnecting it. If the display appears again, contact technical Customer Service and tell them the precise fault code. If the display appears again, contact technical after-sales and tell them the precise fault code.



Customer service

Our after-sales service is there for you if your appliance needs to be repaired. We will always find an appropriate solution, also in order to avoid after-sales personnel having to make unnecessary visits.

E number and FD number

Please quote the E number (product number) and the FD number (production number) of your appliance when contacting the after-sales service.

The rating plate bearing these numbers can be found:

- On the appliance certificate.
- On the lower section of the hob.

The E-number can also be found on the glass surface of the hob. You can check the customer index (KI) and FD number by going to the basic settings. Look up section → *"Basic settings"* for this.

Please note that a visit from an after-sales service engineer is not free of charge in the event of misuse of the appliance, even during the warranty period.

Please find the contact data of all countries in the enclosed customer service list.

To book an engineer visit and product advice

GB 0344 892 8989

Calls charged at local or mobile rate.

IE 01450 2655

0.03 € per minute at peak. Off peak 0.0088 € per minute.

Rely on the professionalism of the manufacturer. You can therefore be sure that the repair is carried out by trained service technicians who carry original spare parts for your appliances.

Test dishes

This table has been produced for test institutes to facilitate the testing of our appliances.

The data in the table refer to our Schulte-Ufer cookware accessories (4-piece cooking set for induction hob Z9442X0) with the following dimensions:

- Saucepan: 16 cm Ø, 1.2 l for 14.5 cm Ø hotplates
- Pot: 16 cm Ø, 1.7 l for 14.5 cm Ø hotplates
- Pot: 22 cm Ø, 4.2 l, for 18 cm Ø hotplates
- Pan: 24 cm Ø, for 18 cm Ø hotplates

Test dishes	Cookware	Heat setting	Preheating		Cooking	
			Cooking time (min:sec)	Lid	Heat setting	Lid
Melting chocolate						
Chocolate coating (e.g. Dr. Oetker brand, dark chocolate 55% cocoa, 150 g)	Saucepan, 16 cm diameter	-	-	-	1.	No
Heating and keeping lentil stew warm						
Lentil stew*						
Initial temperature 20 °C						
Amount: 450 g	Cooking pot, 16 cm diameter	9	1:30 (without stirring)	Yes	1.	Yes
Amount: 800 g	Saucepan, 22 cm diameter	9	2:30 (without stirring)	Yes	1.	Yes
Lentil stew from a tin						
E.g lentils with Erasco sausages.						
Initial temperature 20 °C						
Amount: 500 g	Cooking pot, 16 cm diameter	9	Approx. 1:30 (stir after approx. 1 minute)	Yes	1.	Yes
Amount: 1 kg	Saucepan, 22 cm diameter	9	Approx. 2:30 (stir after approx. 1 minute)	Yes	1.	Yes
Preparing Béchamel sauce						
Temperature of the milk: 7 °C						
Ingredients: 40 g butter, 40 g flour, 0.5 l milk (3.5% fat content) and a pinch of salt						
1. Melt the butter, stir in the flour and salt, and heat up the mixture.	Saucepan, 16 cm diameter	2	Approx. 6:00	No	-	-
2 Add the milk to the roux and bring to the boil, stirring continuously.		7	Approx. 6:30	No	-	-
3. Once the Béchamel sauce comes to the boil, leave it on the hot-plate for a further two minutes, stirring continuously.		-	-	-	2	No
*Recipe in accordance with DIN 44550						
**Recipe in accordance with DIN EN 60350-2						

Test dishes	Cookware	Heat setting	Preheating		Cooking	
			Cooking time (min:sec)	Lid	Heat setting	Lid
Cooking rice pudding						
Rice pudding, cooked with the lid on Temperature of the milk: 7 °C Heat the milk until it starts to rise up. Set the recommended heat setting and add rice, sugar and salt to the milk. The cooking time, including preheating, is approx. 45 minutes.						
Ingredients: 190 g short-grain rice, 90 g sugar, 750 ml milk (3.5% fat content) and 1 g salt	Cooking pot, 16 cm diameter	8.	Approx. 5:30	No	3 (stir after 10 minutes)	Yes
Ingredients: 250 g short-grain rice, 120 g sugar, 1 l milk (3.5% fat content) and 1.5 g salt	Saucepan, 22 cm diameter	8.	Approx. 5:30	No	3 (stir after 10 minutes)	Yes
Rice pudding, cooked without lid Temperature of the milk: 7 °C Add the ingredients to the milk and heat the mixture up while stirring continuously. Once the milk has reached approx. 90 °C, select the recommended heat setting and leave it to simmer on a low heat for approx. 50 minutes.						
Ingredients: 190 g short-grain rice, 90 g sugar, 750 ml milk (3.5% fat content) and 1 g salt	Cooking pot, 16 cm diameter	8.	Approx. 5:30	No	3	No
Ingredients: 250 g short-grain rice, 120 g sugar, 1 l milk (3.5% fat content) and 1.5 g salt	Saucepan, 22 cm diameter	8.	Approx. 5:30	No	2.	No
Cooking rice*						
Water temperature: 20 °C						
Ingredients: 125 g long grain rice, 300 g water and a pinch of salt	Cooking pot, 16 cm diameter	9	Approx. 2:30	Yes	2	Yes
Ingredients: 250 g long grain rice, 600 g water and a pinch of salt	Saucepan, 22 cm diameter	9	Approx. 2:30	Yes	2.	Yes
Roasting a pork loin						
Initial temperature of the loin: 7 °C						
Amount: 3 pork loins (total weight approx. 300 g, 1 cm thick) and 15 ml sunflower oil	Frying pan, 24 cm diameter	9	Approx. 1:30	No	7	No
Preparing pancakes**						
Amount: 55 ml batter for each pancake	Frying pan, 24 cm diameter	9	Approx. 1:30	No	7	No
Deep-fat frying chips						
Amount: 1.8 l sunflower oil, per portion: 200 g frozen chips (e.g. McCain 123 Original fries)	Saucepan, 22 cm diameter	9	Until the oil temperature reaches 180 °C	No	9	No
*Recipe in accordance with DIN 44550						
**Recipe in accordance with DIN EN 60350-2						



Constructa Neff
Vertriebs-GmbH
Carl-Wery-Straße 34
D-81739 München



9001294661
970615(10)
en